

Saari M

Design by Lievore Altherr Molina, 2009

Art. 2711

Armchair (82.5 cm wide seat) with polished or powder-coated four-leg steel base, or with oak effect reconstituted veneer four-leg base. Upholstered shell with metal and plywood frame available in leather, coated fabric, fabric or customer's material. Fully removable cover version available upon request without surcharge.



Dimensions *

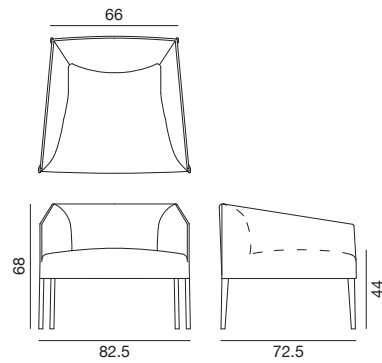

* File CAD 2D - 3D available for download at www.arper.com

Frame Base

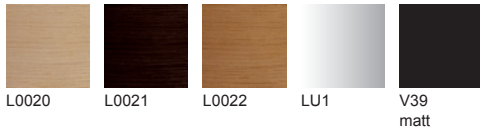

arper

www.arper.com

info@arper.com

Saari M

Design by Lievore Altherr Molina, 2009

Accessories:

Replacement cover set Art.
2716

USB Art. 6001

SHIPMENT DETAILS

Art.2711

1 pz = 1  - kg 19/ m³ 0,671

TECHNICAL SPECIFICATIONS

Art.2711

COL requirement m² 5.29





H 140 cm. COM Meterage m 3.14

FIRE RETARDANT TEST

FIRE RETARDANT TEST

arper

www.arper.com
info@arper.com

-  Upholstery
-  Multi density polyurethans
-  Mono density polyurethans
-  Ovatet and velveteen
-  Wooden structure

