

Mixu Counter Stool

Design in collaboration with Gensler, 2021

Art. 5812

Stool on a four-legged base in chromed or powder-coated steel. Seat upholstered in fabric, leather, coated fabric or customer's own material and polypropylene backrest available in five colours. Seat height 66.5 cm.



Dimensions *

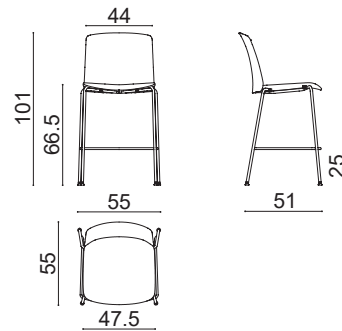

* File CAD 2D - 3D available for download at www.arper.com

Frame Base

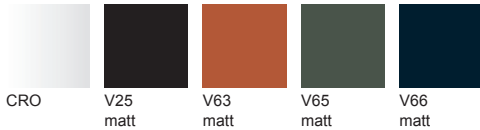

Shell

arper

www.arper.com

info@arper.com

Mixu Counter Stool

Design in collaboration with Gensler, 2021







Accessories:

Single trolley Art. 0500

Stacking protection pad Art.
5830

SHIPMENT DETAILS

Art.5812

1 pz = 1  - kg 9,6/ m² 0,262
1 pz = 1  - kg 9,65/ m² 0,398
2 pz = 1  - kg 16,1/ m² 0,262
2 pz = 1  - kg 16,3/ m² 0,435
4 pz = 1  - kg 29,3/ m² 0,468
4 pz = 1  - kg 29,8/ m² 0,328

- with stacking pad, without tools up to 4 units
- with stacking pad, with trolley up to 4 units

TECHNICAL SPECIFICATIONS

Art.5812

COL requirement m² 1.08
H 140 cm. COM Meterage m 0.616

arper

www.arper.com
info@arper.com

www.arper.com