

aufbauanleitung  
instructions  
notice de montage

Tojo™

schränk

design: Bastian Prieler



Grundmodul  
Basic module  
Module de base



Grundmodul und  
Anbaumodul  
Basic and extended  
module  
Module de base et  
module de attachement

#### Grundmodul / Basic module / Module de base

Paketinhalt / Package content / Contenu de l'emballage:

- 2 x Außenseite / Outer side / Paroi extérieure
- 2 x Boden / floor / Plancher
- 2 x Türen / doors / Portes
- 4 x Sockel/Blende / Skirting board/Aperture / Plinthe/Façade
- 1 x Querstrebe / Cross brace / Traverse
- 2 x Fachboden inkl. Fachbodenträger / Shelf incl. shelf supports / Étagère incl. les supports d'étagère
- 1 x Fachboden mit Kleiderstange / Shelf with clothes rail / Étagère avec tringle à vêtements
- 1 x Rückwand zweiteilig / Two-part back panel / Panneau arrière en deux parties

1 x Zubehör, bestehend aus: / Accessories, consisting of: / Accessoires, comprenant:

- 8 x Holzdübel 8 x 30 für Sockel/Blende / Wooden dowels 8 x 30 for skirting board/aperture / Chevilles en bois 8 x 30 pour plinthe/façade
- 5 x Holzdübel 6 x 30 für Rückwand / Wooden dowels 6 x 30 for back panel / Chevilles en bois 6 x 30 pour panneau arrière
- 10 x Inbus für Eckverbindung / Allen screws for corner connection / Vis Inbus pour connexion d'angle
- 8 x Türscharnier / Door hinges / Charnières de porte
- 8 x Montageplatte / Mounting plates / Plaques de montage

#### Anbaumodul / Extended module / Module de attachement

Paketinhalt / Package content / Contenu de l'emballage:

- 1 x Mittelseite / Middle side / Paroi centrale
- 2 x Boden / floor / Plancher
- 2 x Türen / doors / Portes
- 4 x Sockel/Blende / Skirting board/Aperture / Plinthe/Façade
- 1 x Querstrebe / Cross brace / Traverse
- 2 x Fachboden inkl. Fachbodenträger / Shelf incl. shelf supports / Étagère incl. les supports d'étagère
- 1 x Fachboden mit Kleiderstange / Shelf with clothes rail / Étagère avec tringle à vêtements
- 1 x Rückwand zweiteilig / Two-part back panel / Panneau arrière en deux parties

1 x Zubehör, bestehend aus: / Accessories, consisting of: / Accessoires, comprenant:

- 8 x Holzdübel 8 x 30 für Sockel/Blende / Wooden dowels 8 x 30 for skirting board/aperture / Chevilles en bois 8 x 30 pour plinthe/façade
- 5 x Holzdübel 6 x 30 für Rückwand / Wooden dowels 6 x 30 for back panel / Chevilles en bois 6 x 30 pour panneau arrière
- 10 x Inbus für Eckverbindung / Allen screws for corner connection / Vis Inbus pour connexion d'angle
- 8 x Türscharnier / Door hinges / Charnières de porte
- 8 x Montageplatte / Mounting plates / Plaques de montage

1.

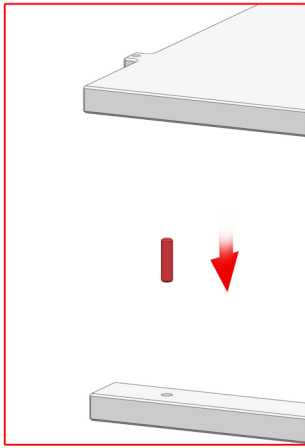
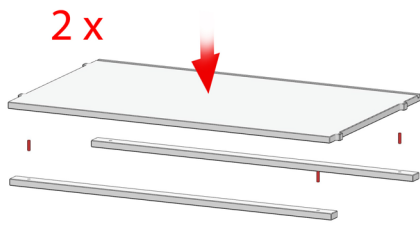

2.

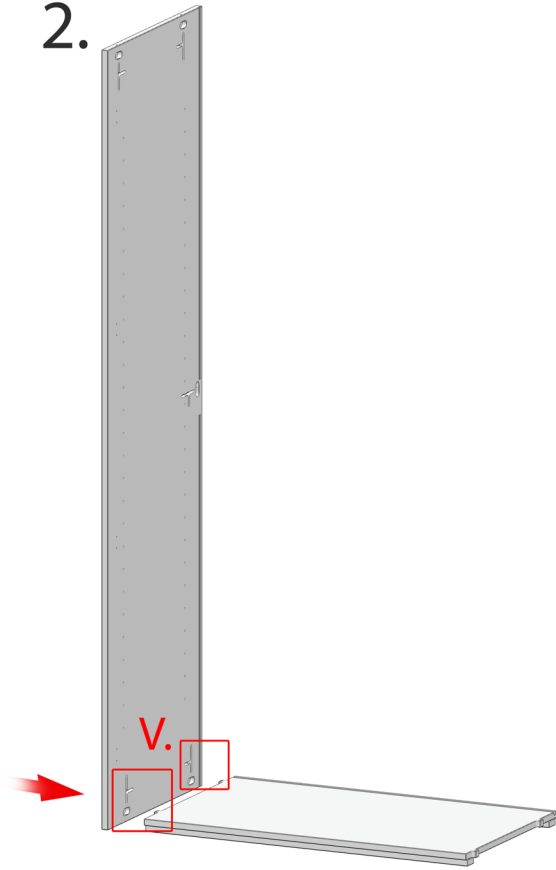

V.

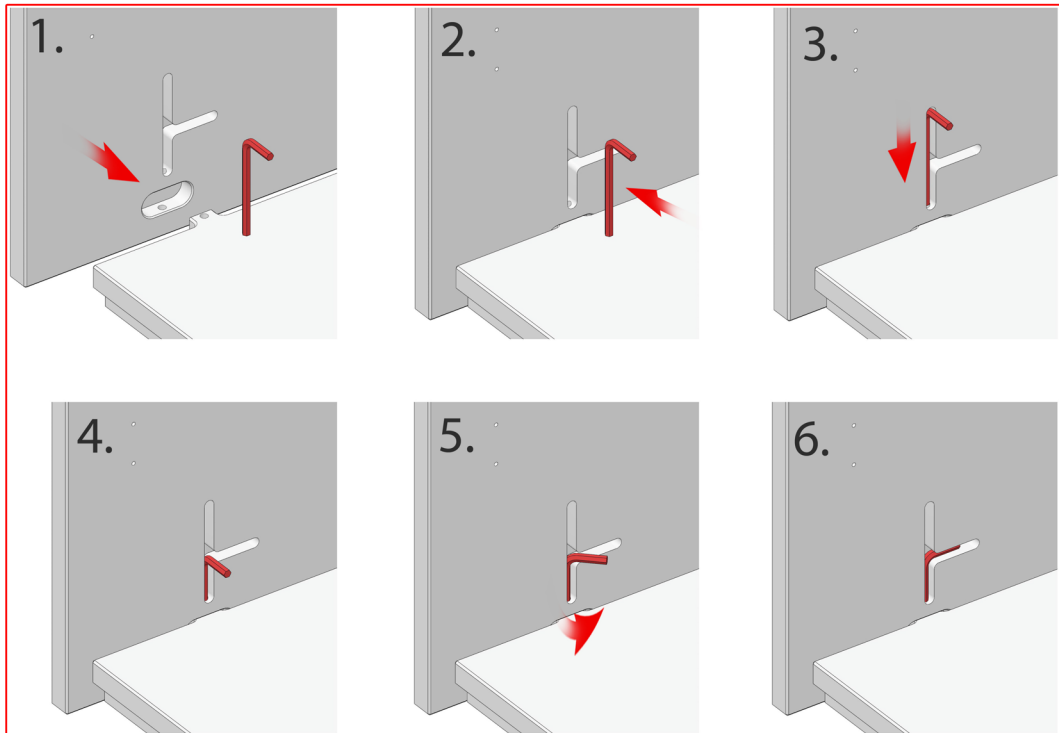

3.

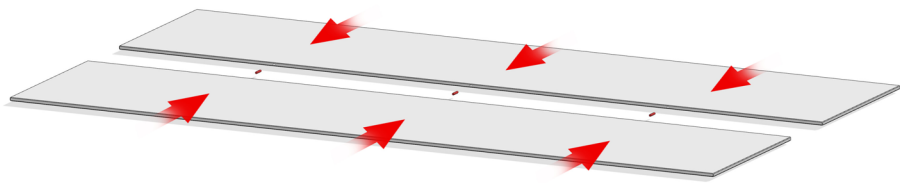

4.

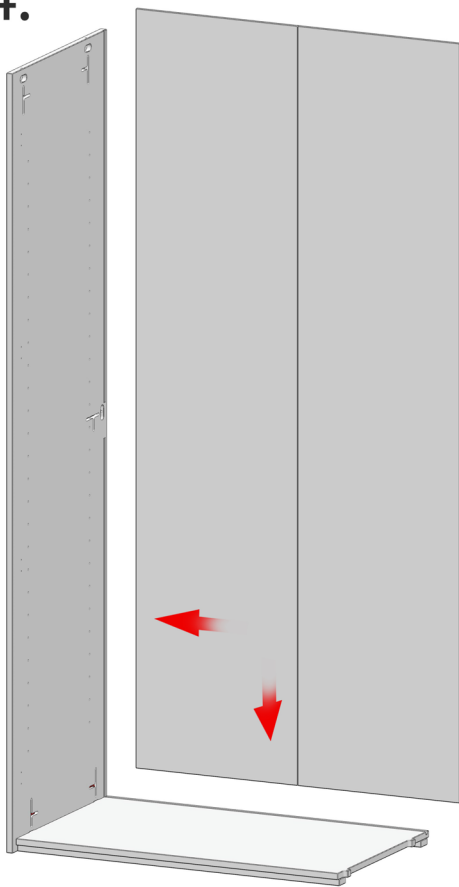

5.

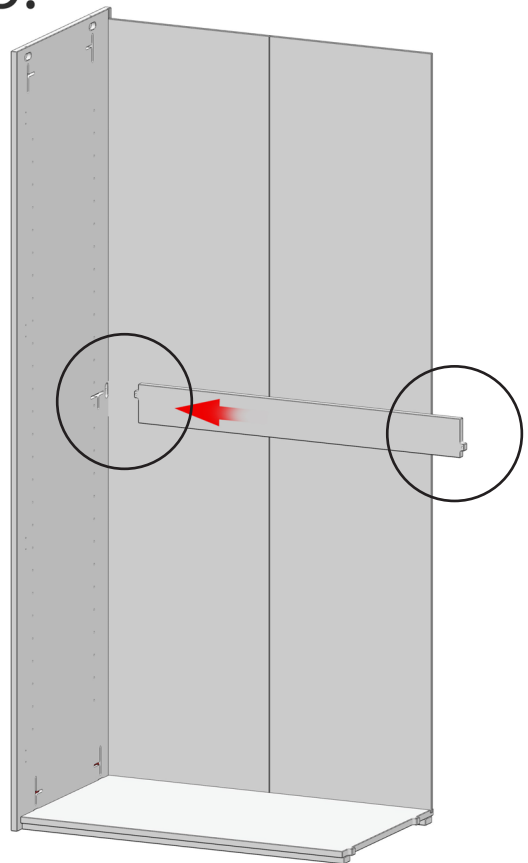

6.

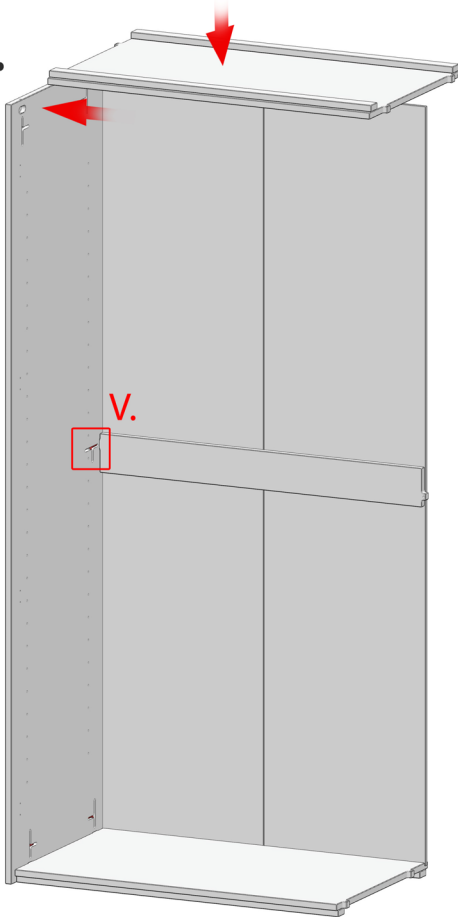

7.

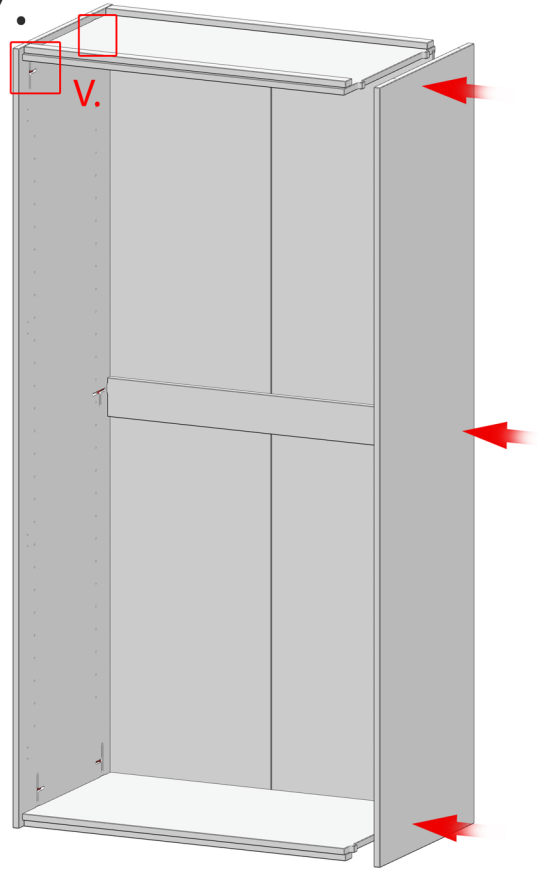

7.2 + (1 x Anbaumodul)

Mittelseite beachten!

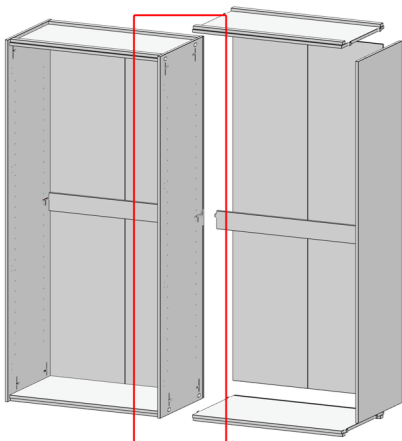

7.3 + (2 x Anbaumodul)

Mittelseite beachten!

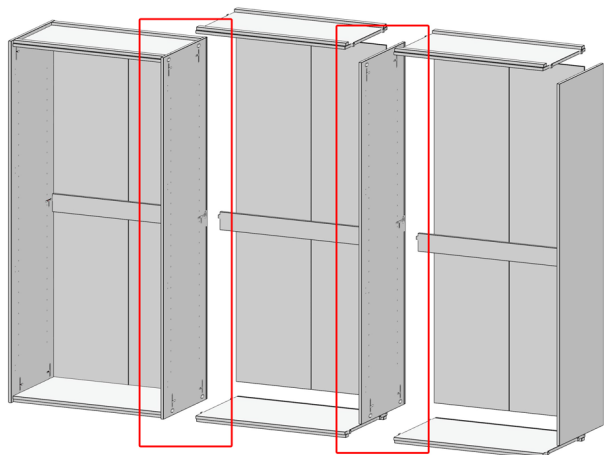

8.

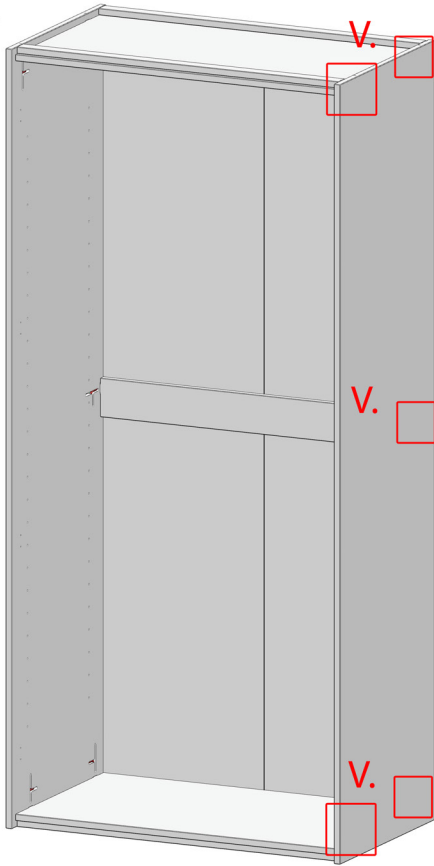

9.

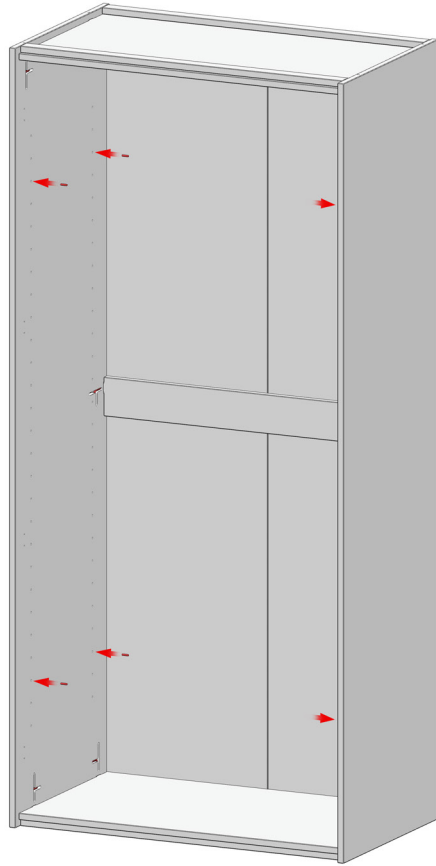

10.

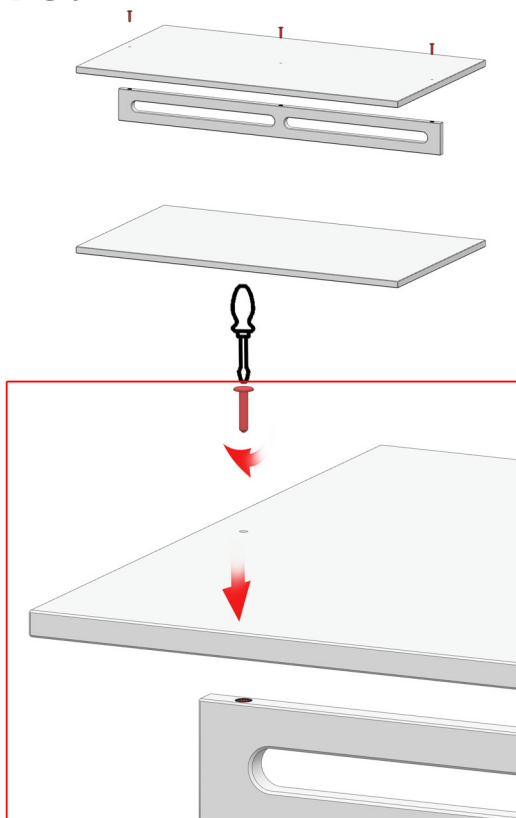

11.

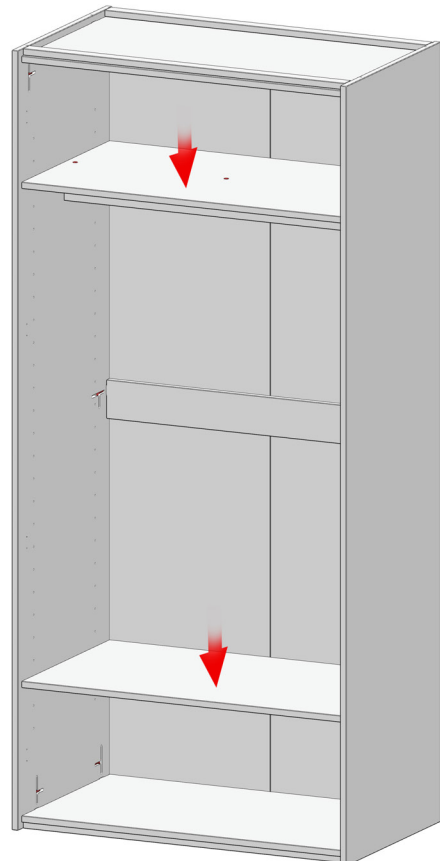

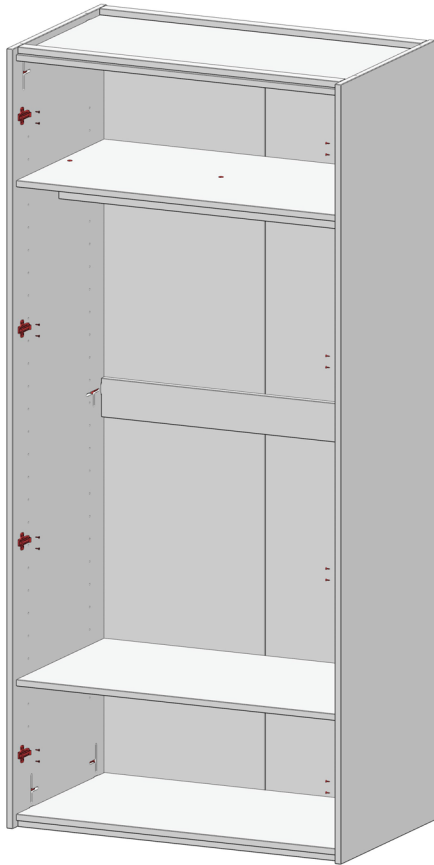

12.

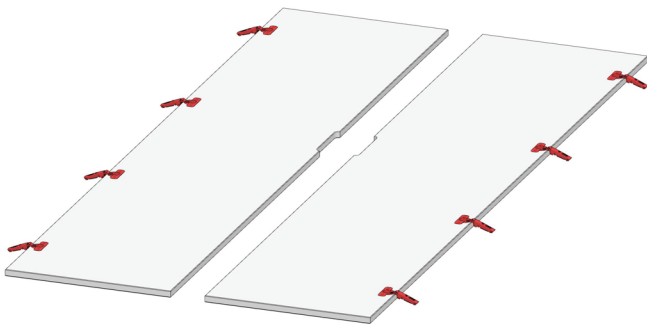
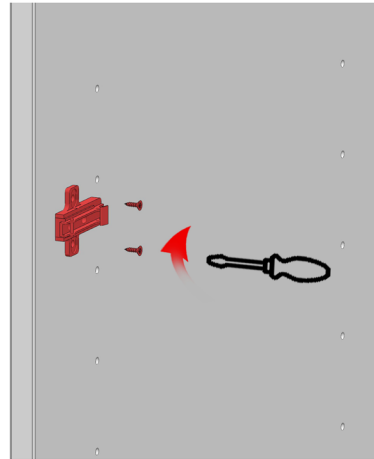

13.



14.

