

Mixu Counter Stool

Design in collaboration with Gensler, 2021

Art. 5811

Stool on a four-legged base in chromed or powder-coated steel. Seat made of plywood with a reconstituted oak finish (natural or stained black) and polypropylene backrest available in five colours. The finishes of the base, seat and backrest can be freely combined. Seat height 65 cm.



Dimensions *

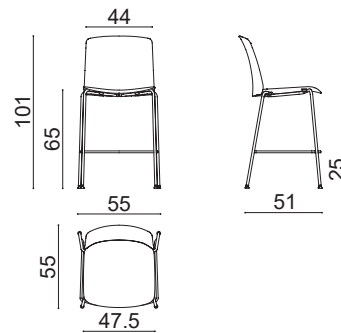

* File CAD 2D - 3D available for download at www.arper.com

Frame Base

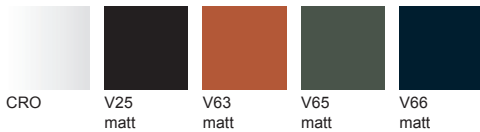

Shell

Wood



arper

www.arper.com

info@arper.com

Mixu Counter Stool







Design in collaboration with Gensler, 2021

Accessories:

Single trolley Art. 0500

SHIPMENT DETAILS

Art.5811

1 pz = 1  - kg 9,6/ m² 0,262
1 pz = 1  - kg 9,65/ m² 0,398
2 pz = 1  - kg 16,1/ m² 0,262
2 pz = 1  - kg 16,3/ m² 0,435
4 pz = 1  - kg 29,3/ m² 0,468
4 pz = 1  - kg 29,8/ m² 0,328

TECHNICAL SPECIFICATIONS

RESISTANCE TEST

- without tools up to 4 units
- with trolley up to 4 units

FIRE RETARDANT TEST

arper

www.arper.com
info@arper.com

www.arper.com