

# Shaal Monomaterial Upholstery

Design by Doshi Levien, 2022

## Art. 6916

3-seater sofa configuration with an outer structure composed of a wraparound panel made of covered plywood. The outer panel and the cushions are upholstered with the same material: fabric, leather, coated fabric or customer's own material. The cushions have removable covers. Base in polypropylene made with recycled materials, equipped with height-adjustable glides.



Dimensions \*

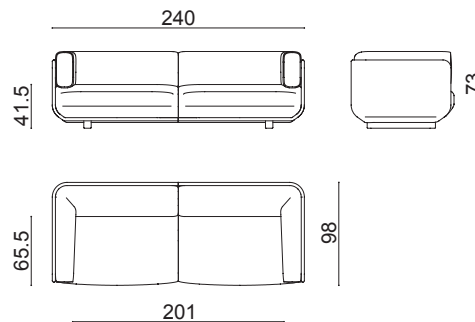

\* File CAD 2D - 3D available for download at [www.arper.com](http://www.arper.com)

Frame Base



P25

arper

www.arper.com

info@arper.com

# Shaal Monomaterial Upholstery

## Design by Doshi Levien, 2022

---

Accessories:

Lumbar cushion 66x32 cm  
Art. 6906

Pillow 60x40 cm Art. 6907

Replacement cover set Art.  
6932

---

### SHIPMENT DETAILS

#### Art.6916

1 pz = 1  - kg 86,48/ m³

1 pz = 2  - kg 150,6/ m³ 2,796

---

### TECHNICAL SPECIFICATIONS

Art.6916

COL requirement m² 46.80

H 140 cm. COM Meterage m 16.06





---

### FIRE RETARDANT TEST

arper

www.arper.com  
info@arper.com

www.arper.com

-  Upholstery
-  Multi density polyurethans
-  Mono density polyurethans
-  Ovatet and velveteen
-  Wooden structure

