

Mixu Counter Stool

Design in collaboration with Gensler, 2021

Art. 5814

Stool on a four-legged base in chromed or powder-coated steel. Seat upholstered with Elmosoft leather or Valencia coated fabric. Backrest upholstered with an alternative material than the one used for the seat, chosen from the Arper portfolio or customer's own material. Seat height 66.5 cm.



Dimensions *

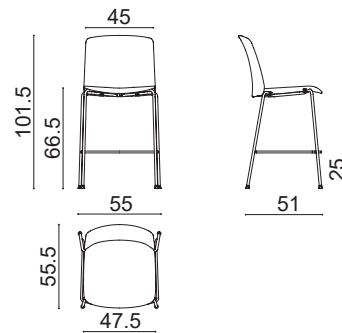

* File CAD 2D - 3D available for download at www.arper.com

Frame Base

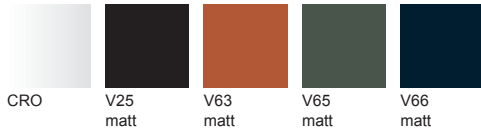

Shell

arper

www.arper.com

info@arper.com

Mixu Counter Stool

Design in collaboration with Gensler, 2021







Accessories:

Single trolley Art. 0500

Stacking protection pad Art.
5830

SHIPMENT DETAILS

Art.5814

1 pz = 1  - kg 9,6/ m² 0,262
1 pz = 1  - kg 9,65/ m² 0,398
2 pz = 1  - kg 16,1/ m² 0,262
2 pz = 1  - kg 16,3/ m² 0,435
4 pz = 1  - kg 29,3/ m² 0,468
4 pz = 1  - kg 29,8/ m² 0,328

- with stacking pad, without tools up to 4 units
- with stacking pad, with trolley up to 4 units

TECHNICAL SPECIFICATIONS

Art.5814

COL requirement m² 2.28
H 140 cm. COM Meterage m 1.18

arper

www.arper.com
info@arper.com

www.arper.com